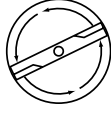

<b>SERVICE</b> 		<b>4</b>
		<b>I0300052</b>

IPL, LT16 A, 2003-01, 106 30 76-61

JNA16H42B

# LT16 A

**Spare parts**

**Ersatzteile**

**Pièces détachées**

**Reserve onderdelen**

**Repuestos**

**Reservdelar**

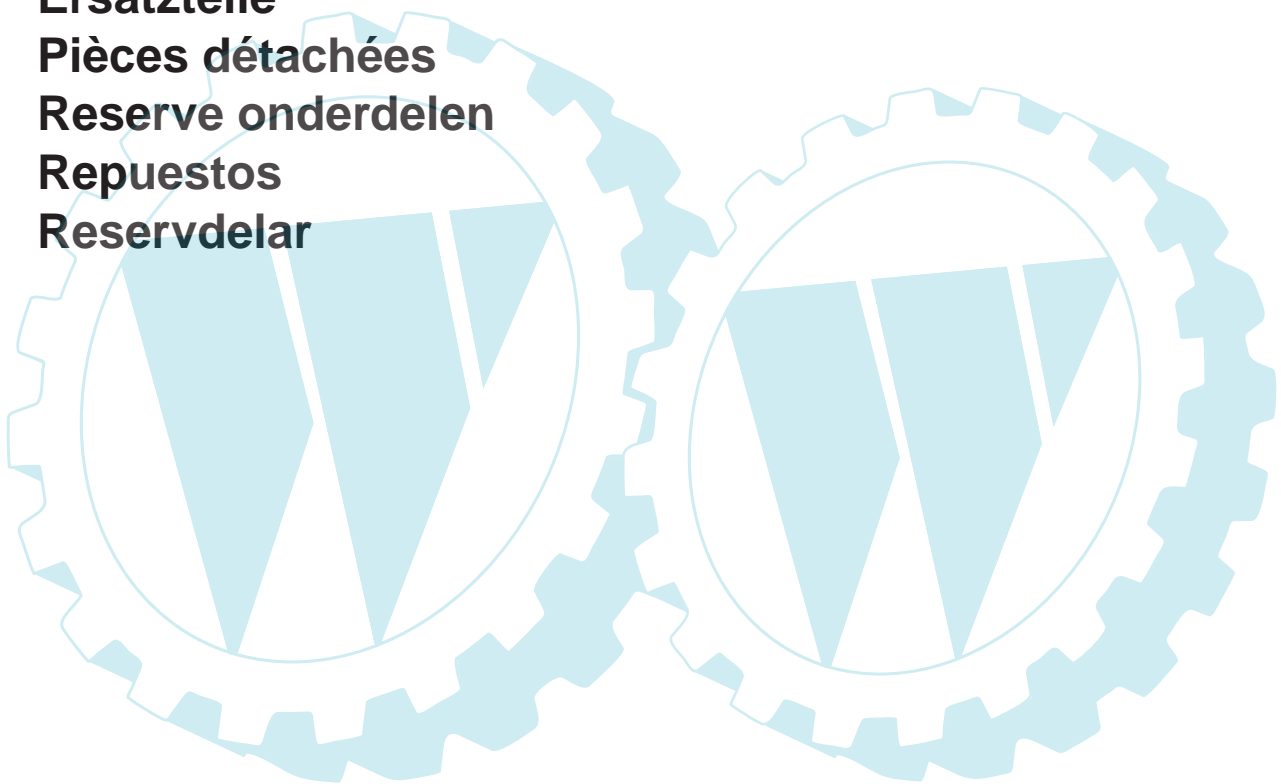

TRACTOR - MODEL NO. LT16A (JNA16H42B), PRODUCT NO. 954 13 00-70  
SCHEMATIC

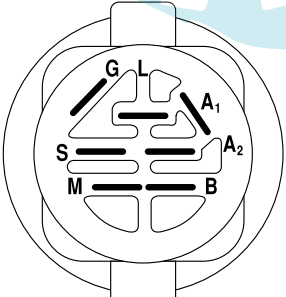
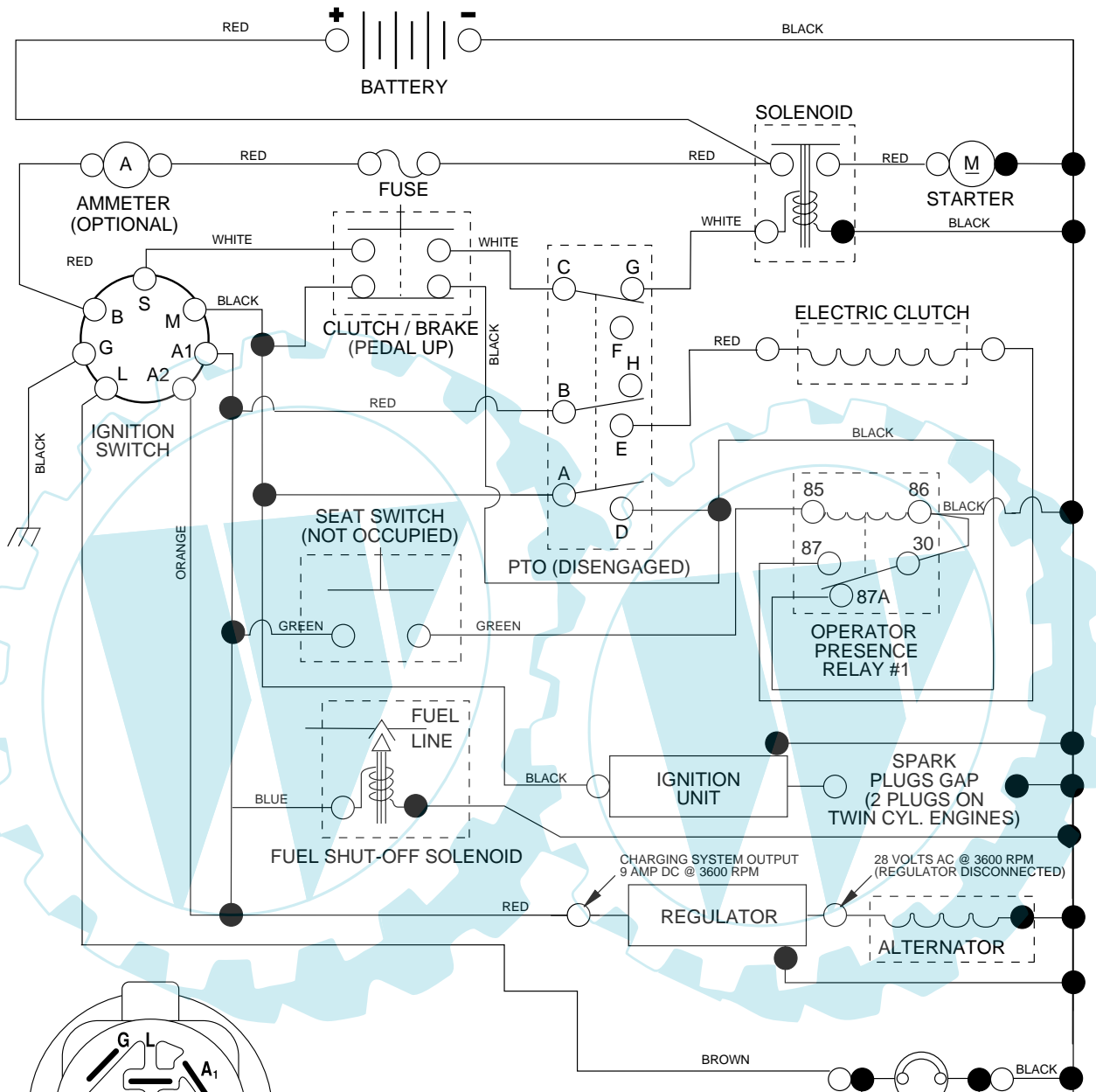

IGNITION SWITCH

POSITION	CIRCUIT	"MAKE"
OFF	M+G+A1	NONE
RUN/LIGHT	B+A1	A2+L
RUN	B+A1	NONE
START	B + S + A1	NONE

**WIRING INSULATED CLIPS**  
NOTE: IF WIRING INSULATED CLIPS WERE REMOVED FOR SERVICING OF UNIT, THEY SHOULD BE REPLACED TO PROPERLY SECURE YOUR WIRING.

PTO SWITCH

POSITION	CIRCUIT
OFF	C + G, B + H
ON	C + F, B + E, A + D

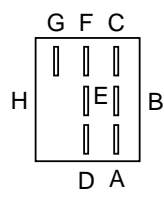
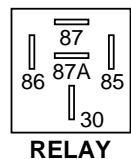
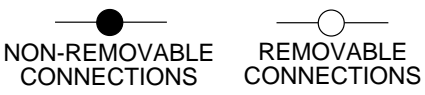

# REPAIR PARTS

TRACTOR - MODEL NO. LT16A (JNA16H42B), PRODUCT NO. 954 13 00-70  
ELECTRICAL

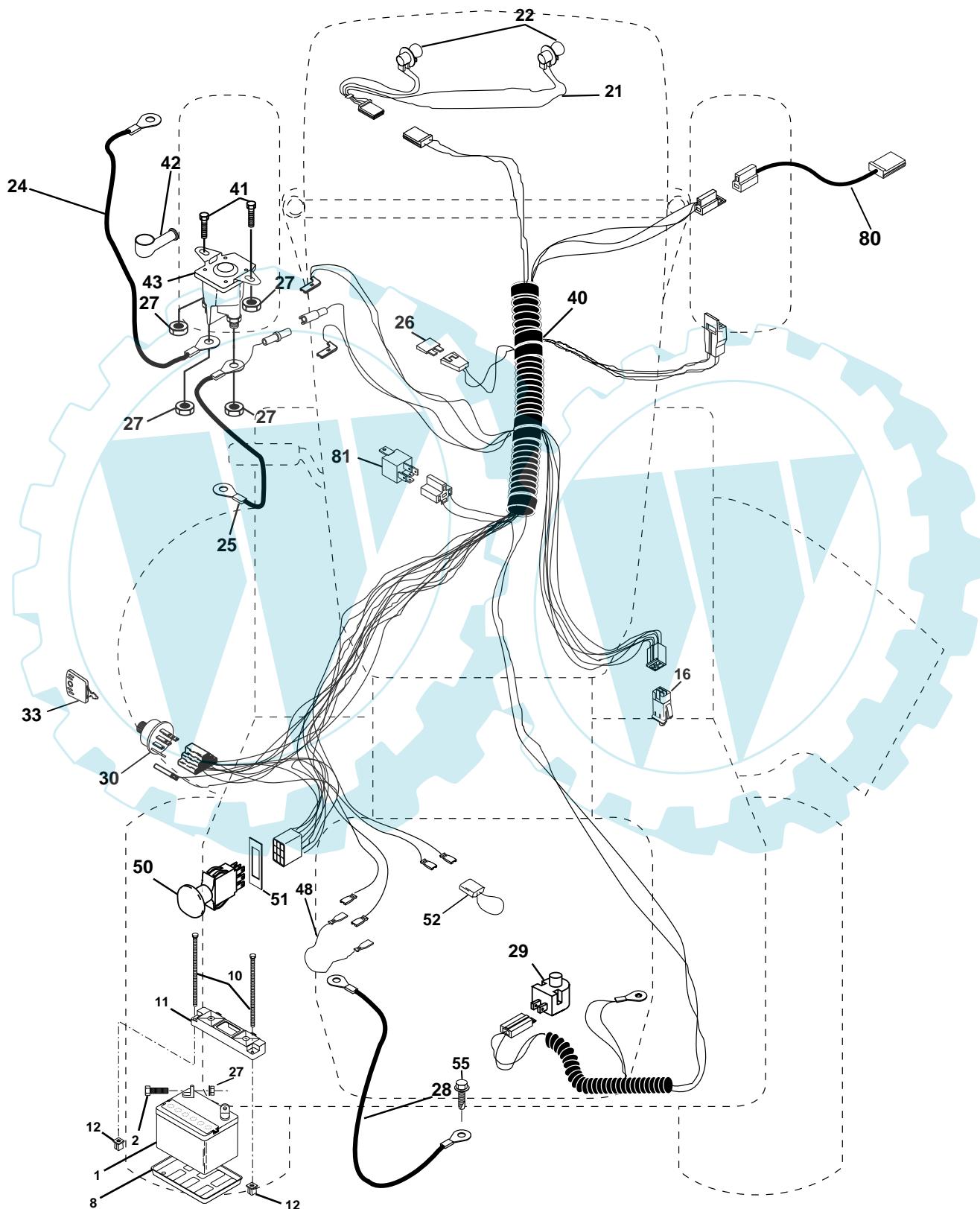

## REPAIR PARTS

TRACTOR - MODEL NO. LT16A (JNA16H42B), PRODUCT NO. 954 13 00-70  
ELECTRICAL

KEY NO.	PART NO.	DESCRIPTION
1	<b>532 16 34-65</b>	Battery 12 Volt 28 AMP
2	874 76 04-12	Bolt Hex Hd 1/4-20unc X 3/4
8	532 12 48-86	Battery Tray
10	532 14 52-11	Bolt Btr Frt
11	532 15 01-09	Hold Down Battery Front
12	532 14 57-69	Nut Push Nylon 1/4
16	<b>532 17 61-38</b>	Switch Interlock
21	<b>532 17 56-85</b>	Harness Asm Light W/4152j
22	532 00 41-52	Bulb Light #1156
24	532 12 47-80	Cable Battery 6 Ga 11" red
25	532 14 61-48	Cable Battery 6 Ga 44" red w/16 wire
26	532 17 51-58	Fuse
27	873 51 04-00	Nut Keps Hex 1/4-20 Unc
28	532 14 54-91	Cable Ground 6 Ga 12" black
29	532 16 07-84	Switch Plunger Nc Gray
30	532 17 55-66	Switch Ign
33	532 14 04-01	Key Ign Generic
40	<b>532 17 97-25</b>	Harness Ign.
41	871 11 04-08	Bolt Blk Fin Hex 1/4 - 20 x 1/2
42	532 13 15-63	Cover Terminal Red
43	532 17 88-61	Solenoid
48	532 14 08-44	Adapter Ammeter Rect.
50	532 17 46-51	Switch PTO
51	532 14 04-05	Ring Retainer PTO
52	532 14 19-40	Protection Wire Loop
55	817 49 05-08	Screw Thdrol 5/16-18 x 1/2
80	532 14 66-85	Harness Clutch Evx
81	532 10 97-48	Relay Asm

**NOTE:** All component dimensions given in U.S. inches.  
1 inch = 25.4 mm.

# REPAIR PARTS

TRACTOR - MODEL NO. LT16A (JNA16H42B), PRODUCT NO. 954 13 00-70  
CHASSIS AND ENCLOSURES

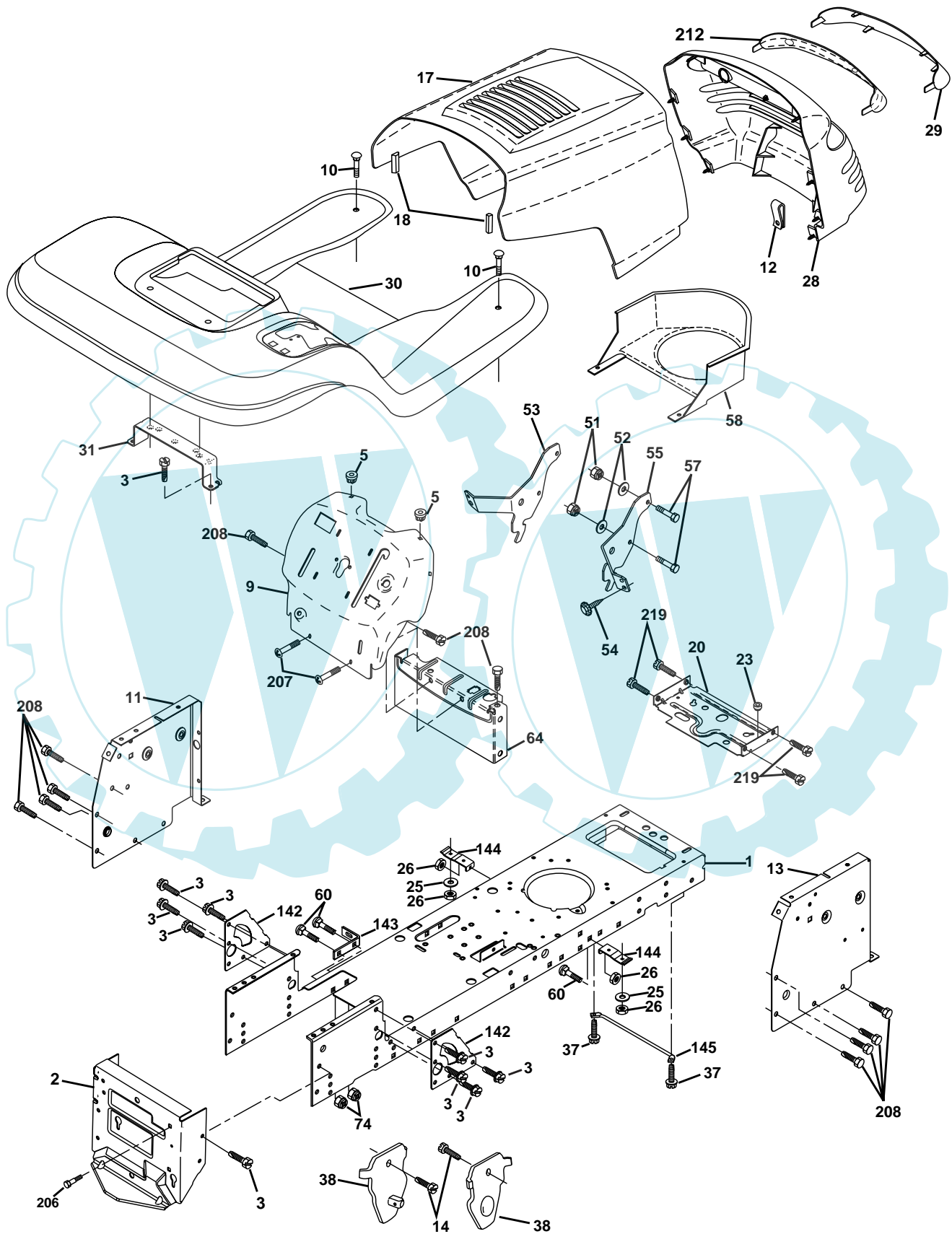

## REPAIR PARTS

### TRACTOR - MODEL NO. LT16A (JNA16H42B), PRODUCT NO. 954 13 00-70 CHASSIS AND ENCLOSURES

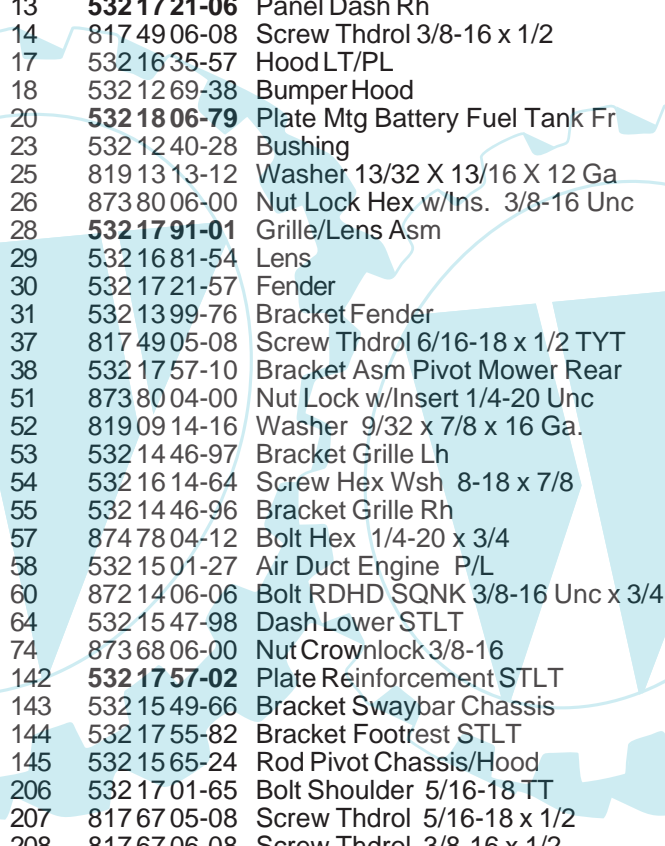

KEY NO.	PART NO.	DESCRIPTION
1	532 17 46-19	Chassis stamping
2	532 17 65-54	Drawbar, 12 Ga.
3	817 06 06-12	Screw 3/8-16x3/4
5	532 15 52-72	Bumper Hood/Dash
9	532 17 22-94	Dash Slkscr
10	872 14 06-08	Bolt Carriage 3/8-16 x 1
11	<b>532 17 49-96</b>	Panel Dash Lh
12	532 14 56-60	Clip Tinnerman
13	<b>532 17 21-06</b>	Panel Dash Rh
14	817 49 06-08	Screw Thdrol 3/8-16 x 1/2
17	532 16 35-57	Hood LT/PL
18	532 12 69-38	Bumper Hood
20	<b>532 18 06-79</b>	Plate Mtg Battery Fuel Tank Fr
23	532 12 40-28	Bushing
25	819 13 13-12	Washer 13/32 X 13/16 X 12 Ga
26	873 80 06-00	Nut Lock Hex w/Ins. 3/8-16 Unc
28	<b>532 17 91-01</b>	Grille/Lens Asm
29	532 16 81-54	Lens
30	532 17 21-57	Fender
31	532 13 99-76	Bracket Fender
37	817 49 05-08	Screw Thdrol 6/16-18 x 1/2 TYT
38	532 17 57-10	Bracket Asm Pivot Mower Rear
51	873 80 04-00	Nut Lock w/Insert 1/4-20 Unc
52	819 09 14-16	Washer 9/32 x 7/8 x 16 Ga.
53	532 14 46-97	Bracket Grille Lh
54	532 16 14-64	Screw Hex Wsh 8-18 x 7/8
55	532 14 46-96	Bracket Grille Rh
57	874 78 04-12	Bolt Hex 1/4-20 x 3/4
58	532 15 01-27	Air Duct Engine P/L
60	872 14 06-06	Bolt RDHD SQNK 3/8-16 Unc x 3/4
64	532 15 47-98	Dash Lower STLT
74	873 68 06-00	Nut Crownlock 3/8-16
142	<b>532 17 57-02</b>	Plate Reinforcement STLT
143	532 15 49-66	Bracket Swaybar Chassis
144	532 17 55-82	Bracket Footrest STLT
145	532 15 65-24	Rod Pivot Chassis/Hood
206	532 17 01-65	Bolt Shoulder 5/16-18 TT
207	817 67 05-08	Screw Thdrol 5/16-18 x 1/2
208	817 67 06-08	Screw Thdrol 3/8-16 x 1/2
212	532 15 62-29	Insert Lens Reflective
219	<b>817 00 05-12</b>	Screw 5/16-18 x 3/4

**NOTE:** All component dimensions given in U.S. inches  
1 inch = 25.4 mm

# REPAIR PARTS

TRACTOR - MODEL NO. LT16A (JNA16H42B), PRODUCT NO. 954 13 00-70  
DRIVE

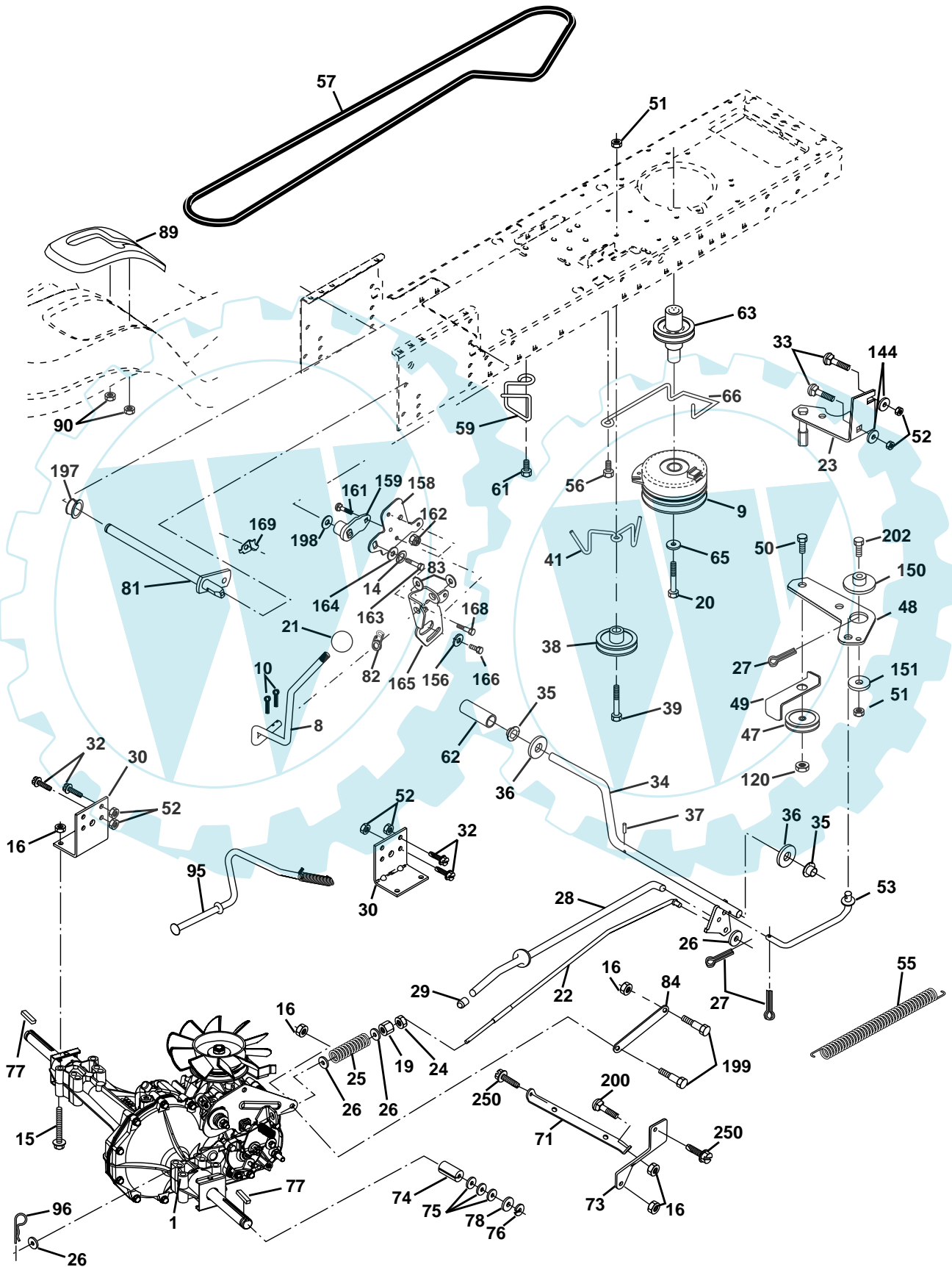

# REPAIR PARTS

## TRACTOR - MODEL NO. LT16A (JNA16H42B), PRODUCT NO. 954 13 00-70 DRIVE

KEY PART NO. NO.	DESCRIPTION	KEY PART NO. NO.	DESCRIPTION
1	----- Transaxle Hydro Gr. 314-0510 (Order parts from transaxle mfg.)	65	8100407-00 Washer Lock Hvy HLCL Spr 7/16
8	532 16 58-66 Rod Shift Fender Adjust STLT	66	532 15 47-78 Keeper Belt Engine
9	532 14 50-28 Clutch Elect Evx	71	532 16 91-83 Strap Torque Lh
10	876 02 04-16 Pin Cotter 1/8 x 1 CAD	73	532 16 91-82 Strap Torque Rh
14	810 04 04-00 Washer Lock Hvy Helical	74	532 13 70-57 Spacer, Axle
15	874 49 05-44 Bolt Hex 5/16-18 Gr. 5	75	532 12 17-49 Washer 25/32 x 1-1/4 x 16 Ga.
16	873 80 05-00 Nut Lock Hex W/Ins. 5/16-18 Unc P	76	812 00 00-01 E-Ring
19	873 80 06-00 Nut Lock Hex W/Ins 3/8-16 Unc	77	532 12 35-83 Key, Square
20	532 15 02-80 Bolt Hex 7/16-20 x 4-1/4	78	532 12 17-48 Washer 25/32 x 1-5/8 x 16 Ga
21	532 14 08-45 Knob Deluxe 1/2-13 UNC BLK/RED	81	532 16 55-96 Shaft Asm Cross Tapered
22	532 16 94-98 Rod, Brake Hydro	82	532 16 57-11 Spring Torsion
23	532 17 12-58 Bracket Asm Anti-Rot Evx	83	819 17 12-16 Washer 17/32 x 3/4 x 16 Ga.
24	873 35 06-00 Nut Hex Jam 3/8-16 UNC	84	532 16 95-94 Link Transaxle
25	532 10 68-88 Spring, Brake Rod	89	532 16 66-02 Console, Hydro
26	819 13 13-16 Washer	90	532 12 43-46 Nut Self-Thd WSHD 1/4
27	876 02 04-12 Pin Cotter 1/8 x 3/4 CAD.	95	532 17 02-01 Control Asm. Bypass Hydro
28	532 17 57-65 Rod, Parking Brake	96	532 12 47-88 Retainer Spring 1" Zinc/Cad
29	532 07 16-73 Cap, Parking Brake	120	873 90 06-00 Nut Lock Flg. 3/8-16
30	532 16 95-92 Bracket, Transaxle	144	819 11 10-16 Washer 11/32 x 5/8 x 16
32	874 76 05-12 Bolt Hex Hd 5/16-18 Unc x 3/4	150	532 17 54-56 Bushing Bellcrank Grd Drive
33	872 14 05-06 Bolt 5/16-18 x 3/4	151	819 13 32-10 Washer 13/32 x 2 x 10 Ga.
34	532 17 55-78 Shaft, Foot Pedal	156	532 16 60-02 Washer Srrted 5/16 ID X 1 X .125
35	532 12 01-83 Bearing, Nylon	158	532 16 55-89 Bracket Shift Mount
36	819 21 16-16 Washer	159	532 16 54-94 Hub Tapered Flange Shift LT
37	532 12 49-63 Pin, Roll	161	872 14 04-06 Bolt Rdhd Sqnk 1/4-20 x 3/4 Gr. 5
38	<b>532 17 91-14</b> Pulley, Idler, Flat	162	873 68 04-00 Nut Crownlock 1/4-20 Unc
39	874 76 06-48 Bolt	163	874 78 04-16 Bolt Hex Fin 1/4-20 Unc x 1 Gr. 5
41	532 17 55-56 Keeper, Belt Idler	164	819 09 10-10 Washer 5/8 x .281 x 10 Ga.
47	532 12 77-83 Pulley, Idler, V-Groove Plastic	165	532 16 56-23 Bracket Pivot Lever
48	532 15 44-07 Bellcrank Clutch Grnd Drv Stl	166	532 16 68-80 Screw 5/16-18 x 5/8
49	532 12 32-05 Retainer, Belt Style Spring	168	532 16 54-92 Bolt Shoulder 5/16-18 x .561
50	874 76 06-24 Bolt Hex Hd 3/8-16 Unc x 1-1/2	169	532 16 55-80 Plate Fastening LT
51	873 68 06-00 Nut	197	532 16 96-13 Nyliner Snap-In 5/8" ID
52	873 68 05-00 Nut Crown Lock 5/16-18	198	532 16 95-93 Washer Nyl 7/8ID x .105 Hyd
53	532 10 57-10 Link, Clutch	199	532 16 96-12 Bolt Shoulder 5/16-18 Unc
55	532 10 57-09 Spring, Return, Clutch	200	872 14 05-08 Bolt Rdhd Sqnk 5/16-18 Unc x 1
56	<b>817 06 06-20</b> Screw 3/8-16 x 1-1/4	202	872 11 06-14 Bolt RDHD 3/8-16 Unc x 1-3/4
57	532 14 02-94 V-Belt, Ground Drive	250	<b>817 06 06-12</b> Screw 3/8-16 x 3/4
59	532 16 96-91 Keeper, Center Span		
61	<b>817 12 06-14</b> Screw 3/8-16 x .875		
62	532 12 48-72 Cover, Pedal		
63	532 17 54-14 Pulley, Engine		

**NOTE:** All component dimensions given in U.S. inches  
1 inch = 25.4 mm



# REPAIR PARTS

TRACTOR - MODEL NO. LT16A (JNA16H42B), PRODUCT NO. 954 13 00-70  
STEERING ASSEMBLY

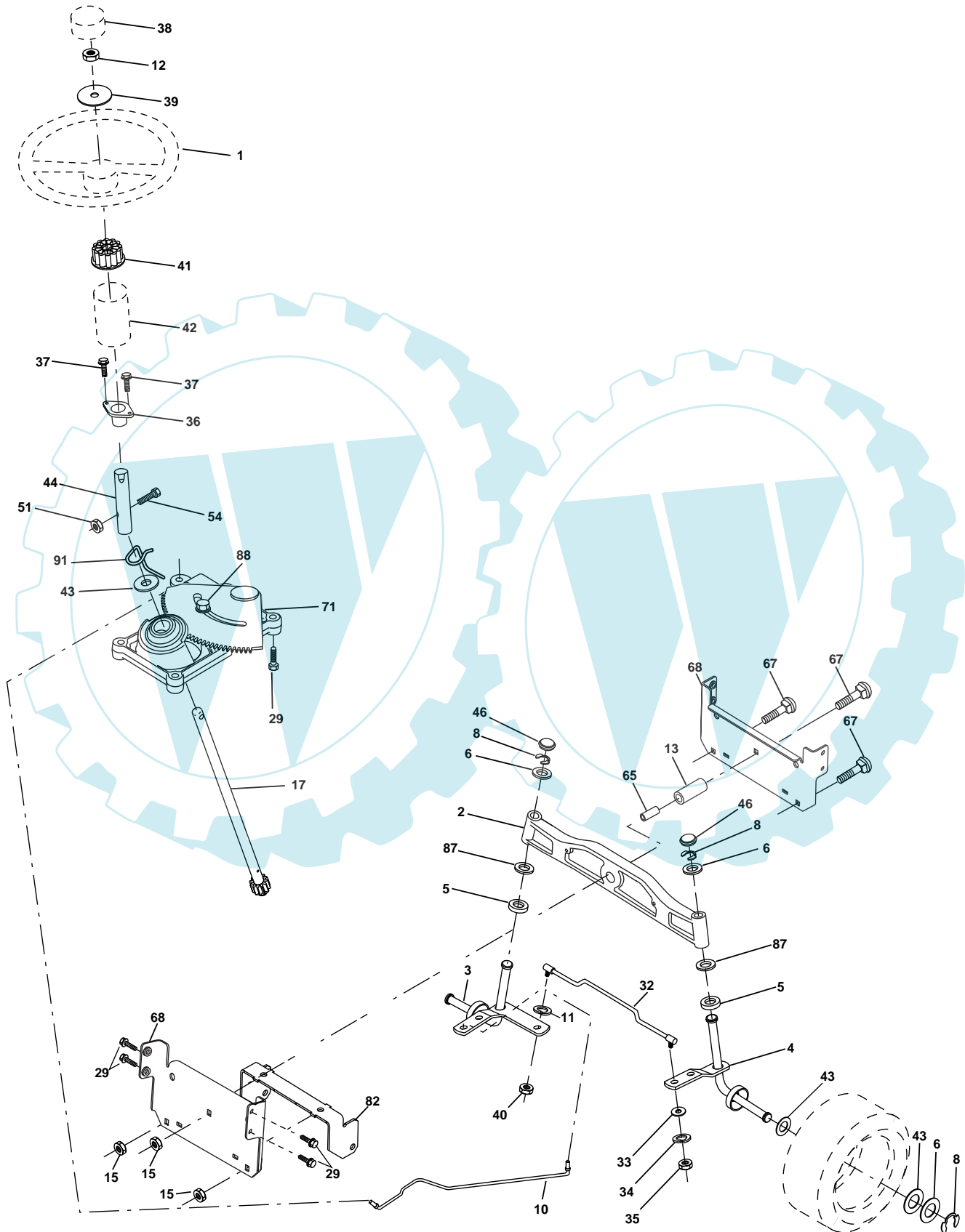

## REPAIR PARTS

TRACTOR - MODEL NO. LT16A (JNA16H42B), PRODUCT NO. 954 13 00-70  
STEERING ASSEMBLY

KEY NO.	PART NO.	DESCRIPTION
1	532 17 20-92	Wheel Steering
2	532 17 23-93	Axle Stamped
3	532 16 98-40	Spindle Asm Cast LH
4	532 16 98-39	Spindle Asm Cast RH
5	532 12 49-31	Bearing Race Thrust Harden
6	532 12 17-48	Washer 25/32 X 1-5/8 X 16 Ga.
8	812 00 00-29	Ring Klip #t5304-75
10	532 17 51-21	Link Drag
11	810 04 06-00	Washer Lock Hvy Hlcl Spr 3/8
12	<b>873 94 08-00</b>	Nut Hex Jam Toplock 1/2-20 unf
13	532 13 65-18	Spacer Brg Axle Front
15	532 14 52-12	Nut Hex Flange Lock Yel D
17	<b>532 18 06-41</b>	Shaft Asm Steering
29	817 06 06-12	Screw 3/8-16 x 3/4
32	532 17 18-88	Rod Tie
33	819 11 12-16	Washer 11/32 x 3/4 x 16 Ga.
34	810 04 05-00	Washer Lock 5/16
35	873 54 05-00	Crownlock Nut 5/16-24
36	532 15 50-99	Bushing Strg
37	532 15 29-27	Screw TT #32.5 x 5 x 3/8 Flange
38	532 17 20-93	Cap Wheel Steer
39	<b>819 18 24-11</b>	Washer 9/16 x 1-1/20 x 11 Ga.
40	532 12 47-01	Nut Lock Center 3/8-24 Unf
41	532 15 99-45	Adaptor Wheel Strg
42	532 16 96-33	Boot Dash Steering
43	532 12 17-49	Washer 25/32 X 1 1/4 X 16 Ga
44	<b>532 18 06-40</b>	Extension Steering
46	532 12 12-32	Cap Spindle Fr Top Blk
51	<b>873 54 04-00</b>	Nut Crownlock 1/4-28
54	<b>871 13 04-20</b>	Bolt Hex 1/4-28unf x 1-1/4
65	532 16 03-67	Spacer, Brace Axle
67	872 14 06-18	Bolt Rdhd 3/8-16 x 2-1/4
68	532 16 98-27	Brace, Axle
71	532 17 51-46	Steering Asm.
82	532 16 98-35	Bracket Susp Chassis Front 15"
87	532 17 39-66	Washer Flat .781 x 1 1/2 x .14
88	532 17 51-18	Bolt Shoulder 7/16-20
91	532 17 55-53	Clip, Steering

**NOTE:** All component dimensions given in U.S. inches.  
1 inch = 25.4 mm.

# REPAIR PARTS

TRACTOR - MODEL NO. LT16A (JNA16H42B), PRODUCT NO. 954 13 00-70  
SEAT ASSEMBLY

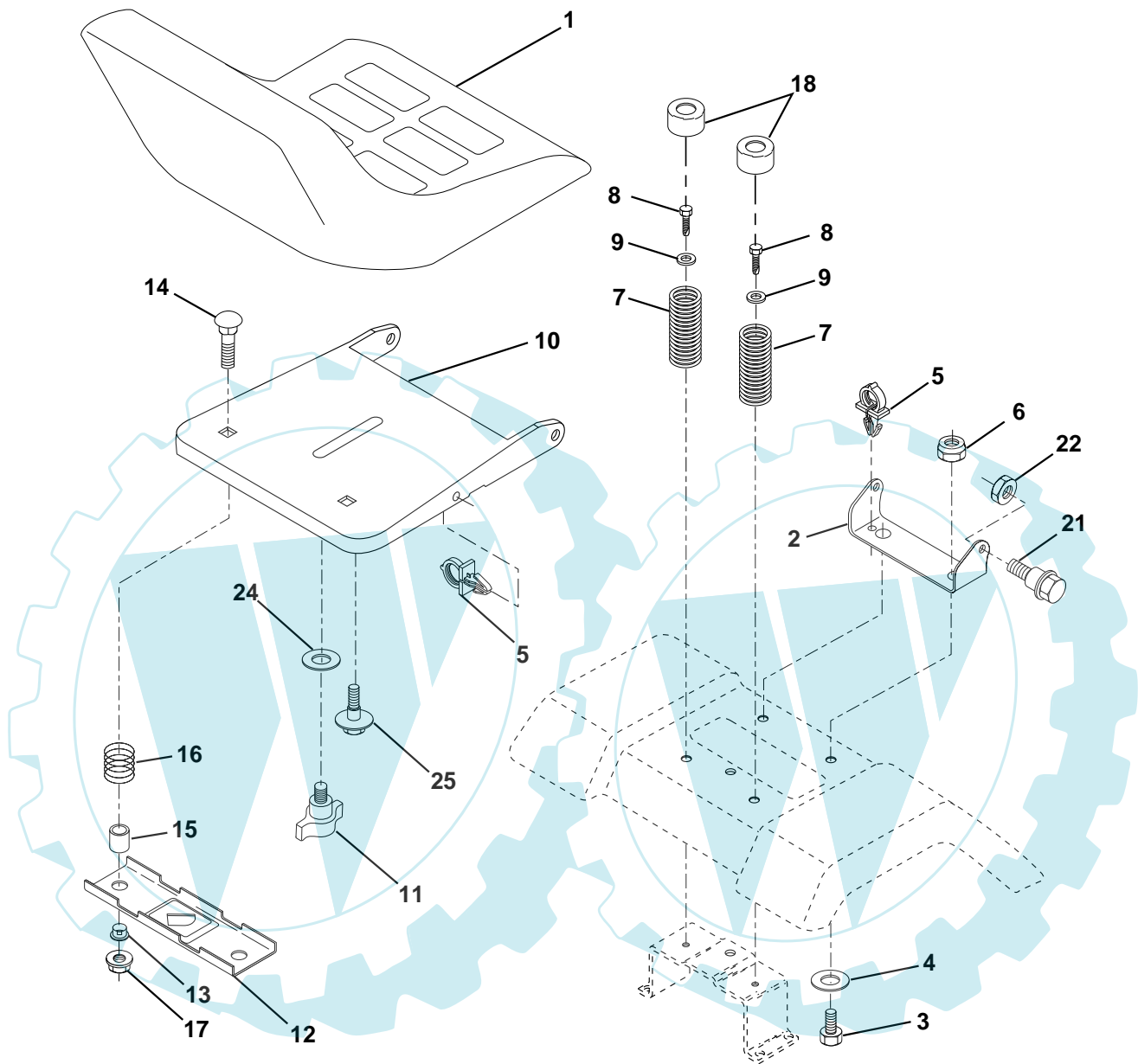

KEY NO.	PART NO.	DESCRIPTION
1	532 14 01-18	Seat
2	532 14 05-51	Bracket Pivot Seat 8 720
3	871 11 06-16	Bolt Fin Hex 3/8-16unc X 1
4	819 13 16-10	Washer 13/32 X 1 X 10 Ga
5	532 14 50-06	Clip Push-In
6	873 80 06-00	Nut Hex w/Ins. 3/8-16 Unc
7	532 12 41-81	Spring Seat Cprsn 2 250 Blk Zi
8	817 00 06-16	Screw 3/8-16 X 1
9	819 13 16-14	Washer 13/32 X 1 X 14 Ga.
10	<b>532 18 24-93</b>	Pan Seat
11	532 16 63-69	Knob Seat Adj Wingnut
12	532 12 12-46	Bracket Mounting Switch

KEY NO.	PART NO.	DESCRIPTION
13	532 12 12-48	Bushing Snap Blk Nyl 50 Id
14	872 05 04-12	Bolt Rdhd Sqnk 1/4-20x1-1/2
15	532 12 12-49	Spacer Split 28x 96 Yel Zinc
16	532 12 37-40	Spring Cprsn 1 27 Blk Pnt
17	532 12 39-76	Nut Lock 1/4 Lge Flg Gr 5 Zinc
18	532 12 42-38	Cap, Spring Seat 1.75 x 1.0
21	532 17 18-52	Bolt Shoulder 5/16-18 Unc
22	873 80 05-00	Nut Hex Lock W/Ins 5/16-18
24	819 17 19-12	Washer 17/32 X 1-3/16 X 12 Ga.
25	532 12 70-18	Bolt Shoulder 5/16-18 X 62

**NOTE:** All component dimensions given in U.S. inches.  
1 inch = 25.4 mm

# REPAIR PARTS

TRACTOR - MODEL NO. LT16A (JNA16H42B), PRODUCT NO. 954 13 00-70  
DECALS

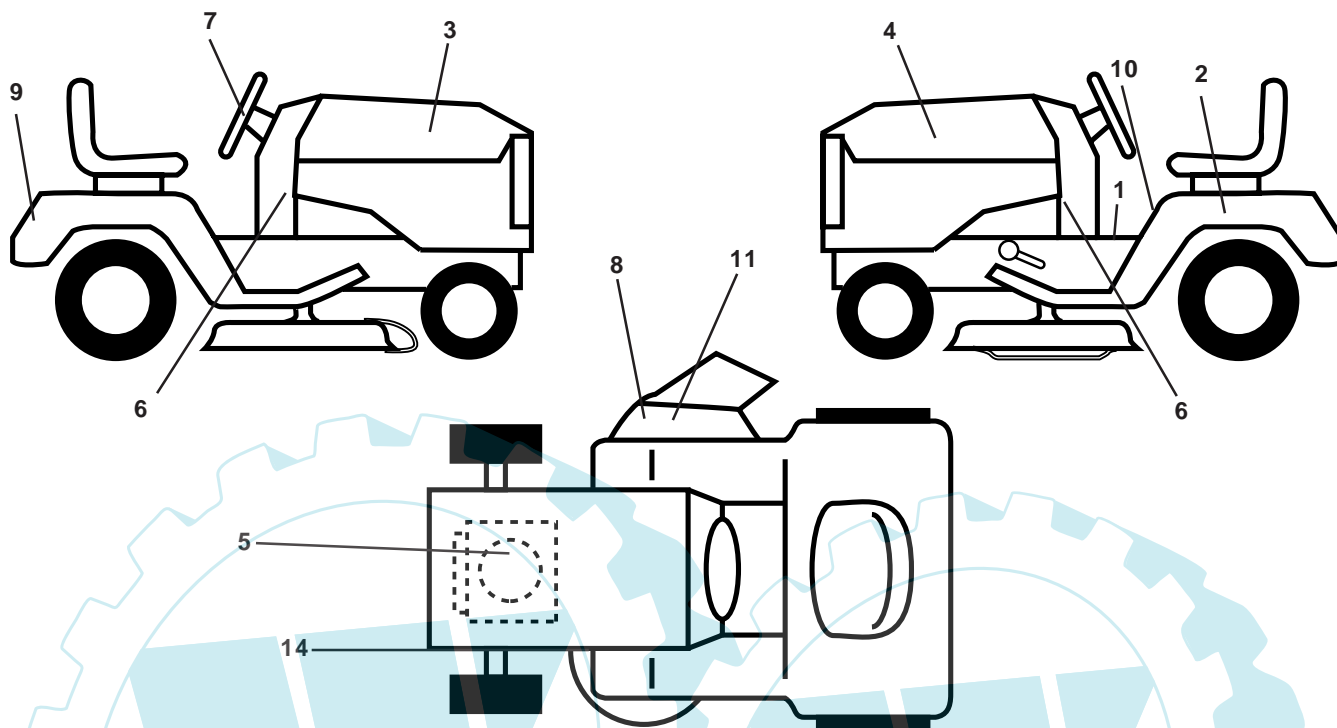

KEY NO.	PART NO.	DESCRIPTION
1	532 15 70-32	Decal Oper. Step Thru E/F
2	532 14 50-05	Decal Battery
3	532 17 06-00	Decal Hood RH
4	532 17 06-01	Decal Hood LH
5	<b>532 18 04-34</b>	Decal HP Engine
6	532 16 29-27	Decal Hood/Sd Pnl
7	532 17 05-65	Decal Wheel Steering
8	532 17 05-63	Decal Warning
9	532 14 17-61	Decal Fender

KEY NO.	PART NO.	DESCRIPTION
10	532 15 71-40	Decal Fender Danger
11	<b>532 17 91-28</b>	Decal Deck "B" 42
14	532 16 03-96	Decal V-Belt Schematic
--	<b>532 17 12-84</b>	Pad Footrest LH
--	<b>532 17 12-85</b>	Pad Footrest RH
--	532 13 83-11	Decal Handle Lft Height Adjust
--	532 16 92-10	Decal By Pass Lt Hydro
--	<b>532 17 99-38</b>	Manual Owner's (English)
--	<b>532 17 99-39</b>	Manual Owner's (French)

## WHEELS & TIRES

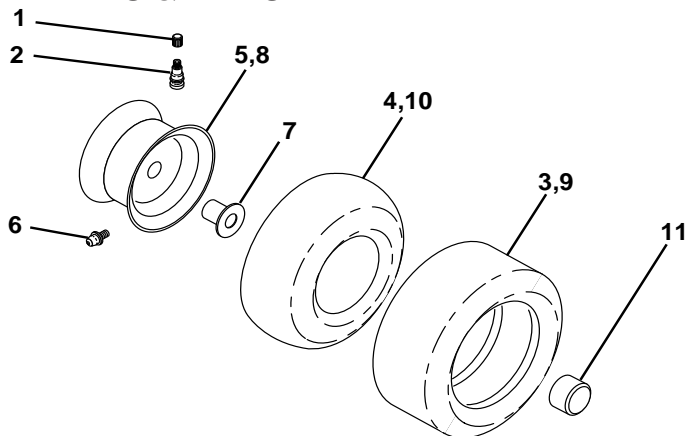

KEY NO.	PART NO.	DESCRIPTION
1	532 05 91-92	Cap Valve Tire
2	532 06 51-39	Stem Valve
3	532 10 62-22	Tire F Ts 15 X 6 0 - 6 Service
4	532 05 99-04	Tube Front (Service Item Only)
5	532 13 83-36	Rim Asm 6" front Silver Service
6	532 12 49-57	Fitting Grease (Front Wheel Only)
7	532 12 49-59	Bearing Flange (Front Wheel Only)
8	532 13 83-37	Rim Asm 8" rear Silver Service
9	532 12 20-82	Tire R Ts 20x10-8 C Service
10	532 12 49-26	Tube Rear (Service Item Only)
11	532 17 50-39	Cap Axle Blk 1 50 X 1 00
--	532 14 43-34	Sealant, Tire ( 10 oz. Tube)

**NOTE:** All component dimensions given in U.S. inches.  
1 inch = 25.4 mm

# REPAIR PARTS

TRACTOR - MODEL NO. LT16A (JNA16H42B), PRODUCT NO. 954 13 00-70  
ENGINE

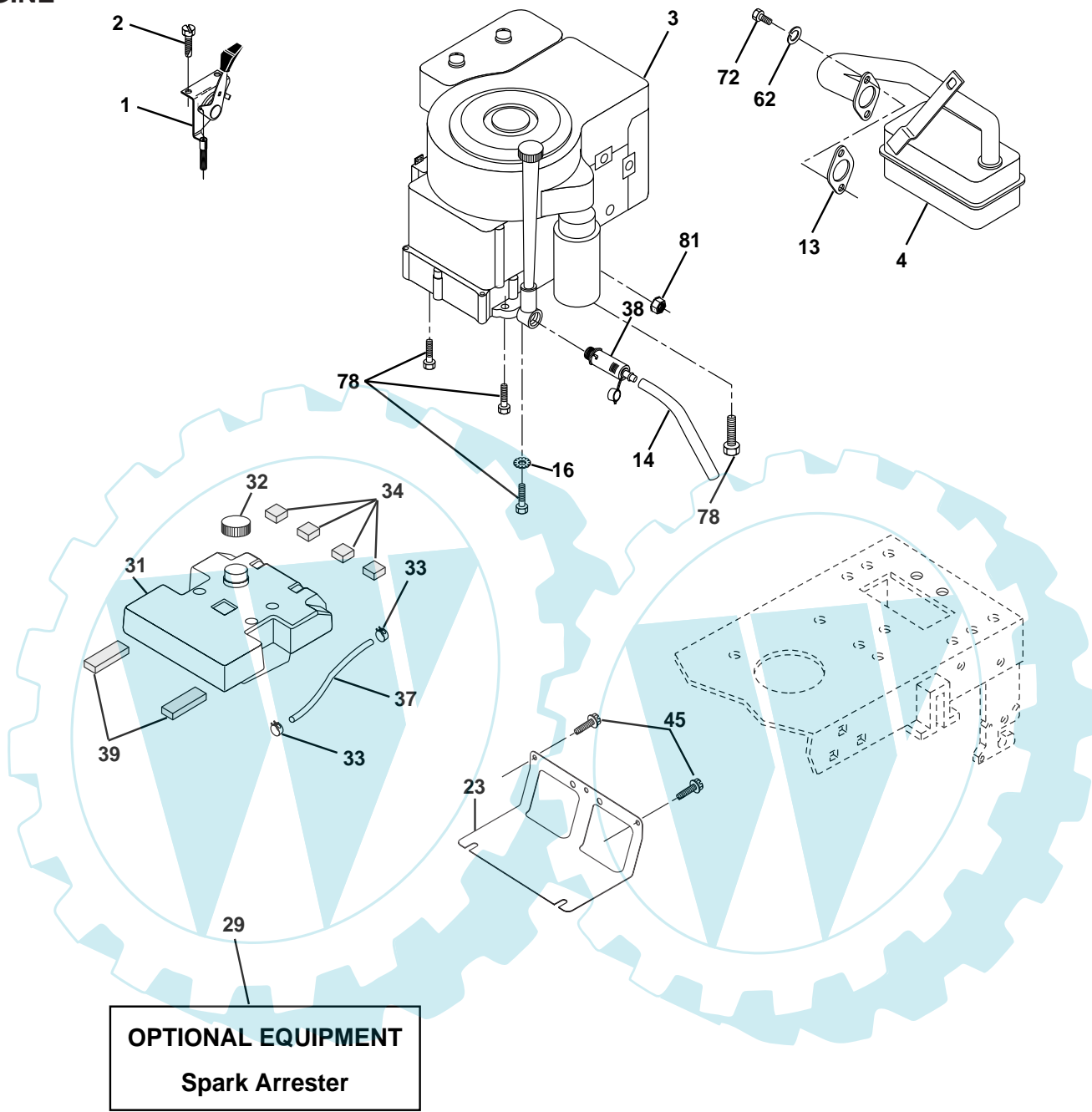

**OPTIONAL EQUIPMENT**  
**Spark Arrester**

KEY NO.	PART NO.	DESCRIPTION
1	532 17 05-51	Control Th/ch Flag Dom.
2	817 72 04-08	Screw Hex Thd Cut 1/4-20x5/8 T
3	-----	Engine B&S Model 31G777 (Order parts from engine manufacturer)
4	532 13 73-52	Muffler
13	532 16 52-91	Gasket
14	532 14 84-56	Tube Drain Oil Easy
16	811 05 06-00	Washer Lock Ext Tooth 3/8
23	532 16 98-37	Shield BRN/DBR Guard
29	532 13 71-80	Kit Spark Arrester (Flat Scrn)
31	532 15 71-03	Tank Fuel
32	532 14 05-27	Cap Asm Fuel W/sym Vented

KEY NO.	PART NO.	DESCRIPTION
33	532 12 34-87	Clamp Hose Black
34	532 10 60-82	Pad Spacer 1 x 1 x 1
37	532 14 21-58	Line Fuel
38	532 14 83-15	Plug Drain Oil Easy
39	532 10 92-27	Pad Idler
45	817 00 06-12	Screw Hex Wsh Thdrol 3/8-16 x 3/4
62	810 04 05-00	Washer Lock Hvy Hlcl Spr. 5/16
72	871 07 05-12	Screw Hex Hd Cap 5/16-18 x 3/4
78	817 06 06-20	Screw 3/8-16 x 1-1/4
81	873 51 04-00	Nut Keps Hex 1/4-20 Unc

**NOTE:** All component dimensions given in U.S. inches  
1 inch = 25.4 mm

# REPAIR PARTS

TRACTOR - MODEL NO. LT16A (JNA16H42B), PRODUCT NO. 954 13 00-70  
MOWER LIFT

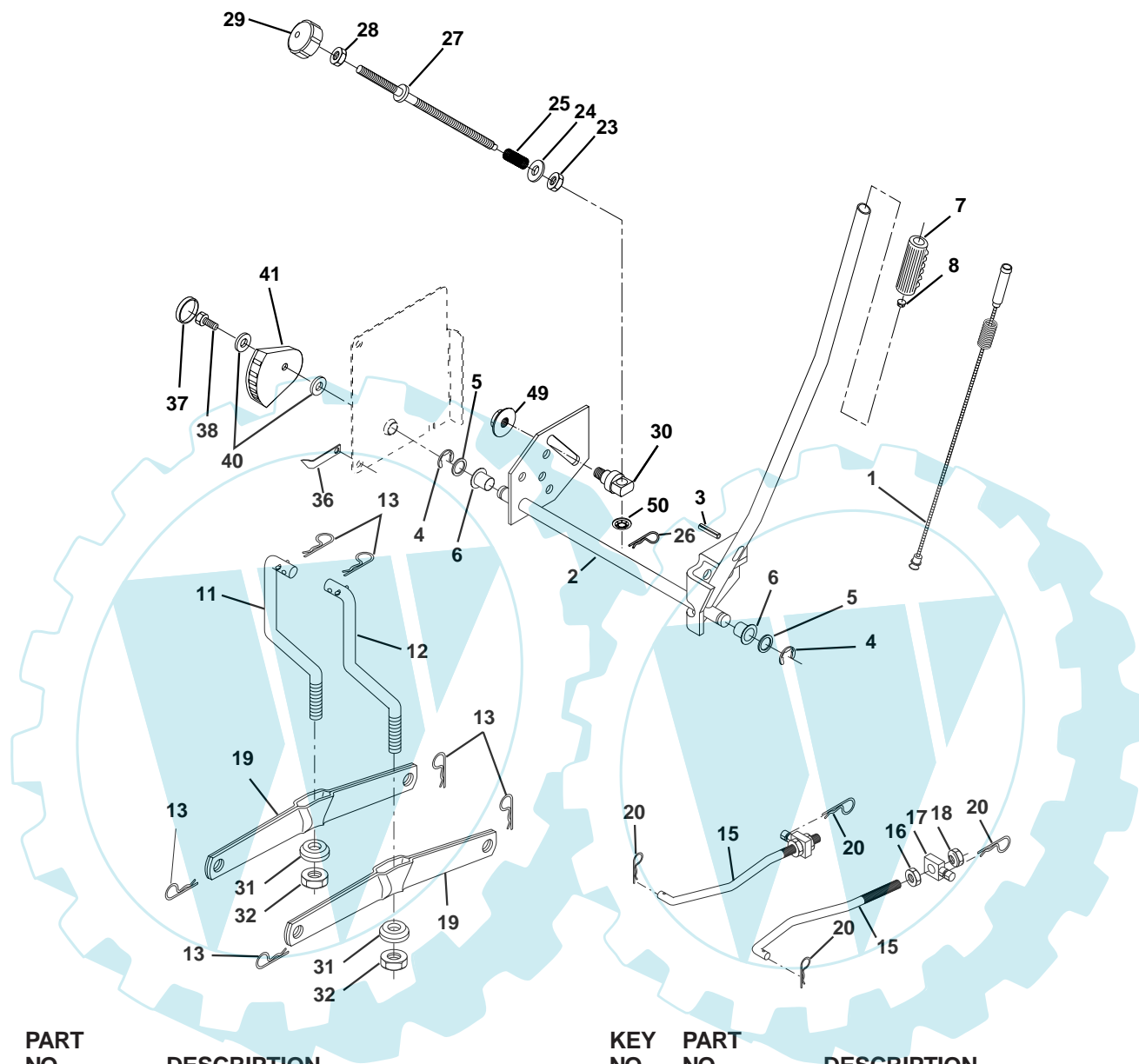

KEY NO.	PART NO.	DESCRIPTION
1	532 15 94-60	Wire Asm Inner W/plunger
2	532 15 94-71	Shaft Asm Lift RH w/Inf
3	532 10 57-67	Pin Groove 1 500 Zinc
4	812 00 00-02	E Ring #5133-62
5	819 21 16-21	Washer 21/32 X 1 X 21 Ga
6	532 12 01-83	Bearing Nylon Blk 629 Id
7	532 12 56-31	Grip Handle Fluted Blk
8	532 12 45-26	Button Plunger Black
11	532 13 98-65	Link Lift LH Fixed Length
12	532 13 98-66	Link Lift RH Fixed Length
13	532 12 46-70	Retainer Spring
15	532 17 32-88	Link Front
16	873 35 08-00	Nut Jam Hex 1/2-13 Unc
17	532 17 56-89	Trunnion Blk Zinc
18	873 80 08-00	Nut Lock w/Wsh 1/2-13unc
19	532 13 98-68	Arm Suspension Rear
20	532 16 35-52	Retainer Spring
23	532 11 08-07	Nut Special

KEY NO.	PART NO.	DESCRIPTION
24	819 13 10-16	Washer 13/32 X 5/8 X 16 Ga
25	532 12 48-74	Spring 2-1/8"
26	532 16 94-84	Retainer Clip
27	532 12 69-71	Rod Adj Lift Zinc 7.49 Wrk Lg
28	873 35 06-00	Nut Hex Jam 3/8-16 Unc
29	532 13 80-57	Knob Inf 3/8-16 Unc Blk W/sym
30	532 15 02-33	Trunnion Infin Height
31	532 16 98-65	Bearing Pvt Lift
32	873 54 06-00	Nut Crownlock 3/8 - 24
36	532 15 50-97	Pointer Height Indicator
37	532 12 39-35	Plug Hole Blk 1.485/1.515 Dia.
38	817 06 05-16	Screw 5/16-18 x 1
40	819 11 24-10	Washer 11/32 x 1-1/2 10 Ga.
41	532 15 50-98	Indicator Height STLT
49	532 14 52-12	Nut Hex Flange Lock
50	532 11 04-52	Nut Phos & Oil

**NOTE:** All component dimensions given in U.S. inches  
1 inch = 25.4 mm

# REPAIR PARTS

TRACTOR - MODEL NO. LT16A (JNA16H42B), PRODUCT NO. 954 13 00-70  
MOWER DECK

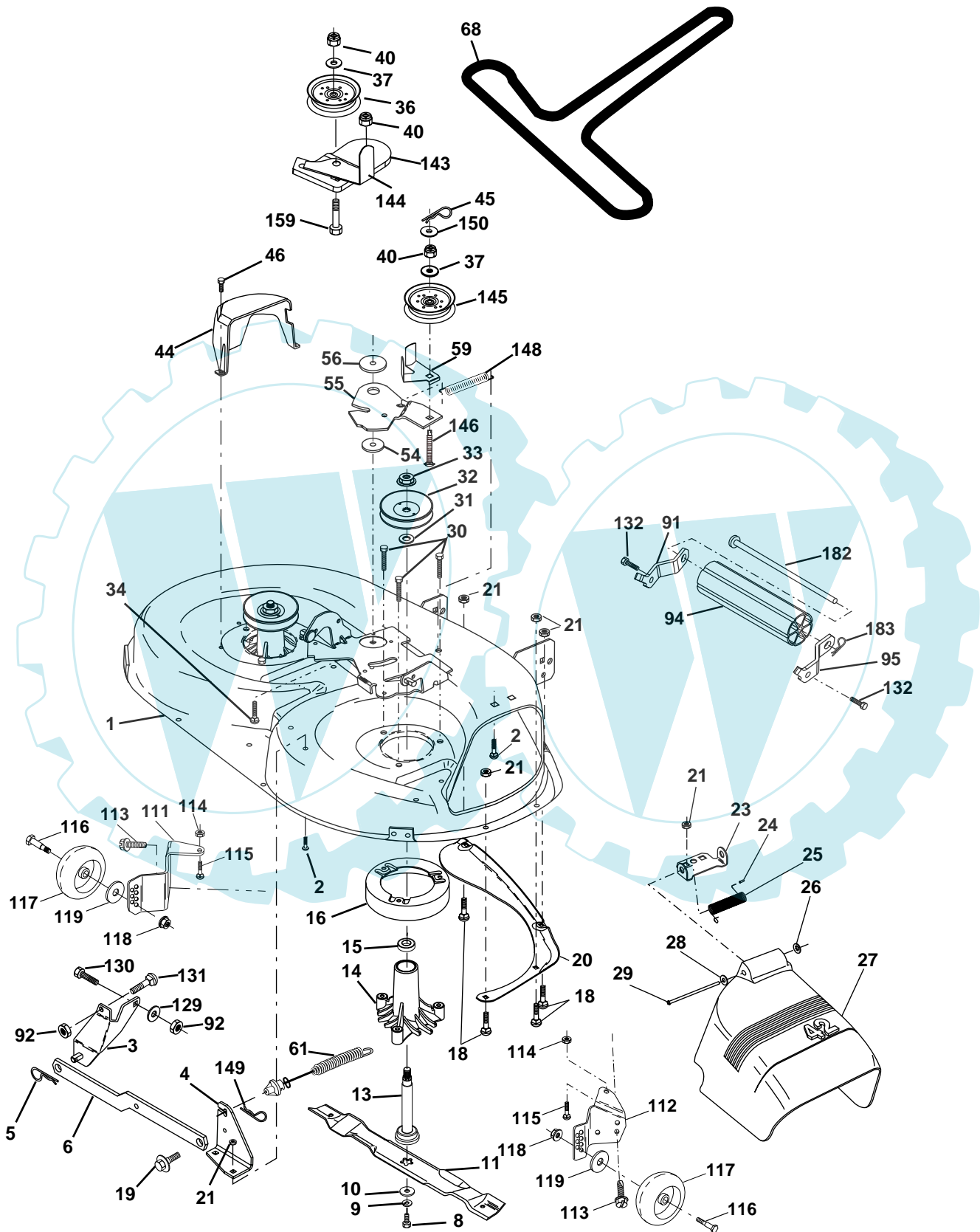

## REPAIR PARTS

TRACTOR - MODEL NO. LT16A (JNA16H42B), PRODUCT NO. 954 13 00-70  
MOWER DECK

KEY NO.	PART NO.	DESCRIPTION	KEY NO.	PART NO.	DESCRIPTION
1	532 16 58-92	Mower Deck Assembly, 42"	55	532 15 50-46	Arm, Idler
2	872 14 05-06	Bolt	56	532 16 57-23	Spacer, Retainer
3	532 13 80-17	Bracket Assembly, Sway Bar, Front	59	532 14 10-43	Guard, TUV Idler
4	532 16 54-60	Bracket Sway Bar 38/42" Deck	61	532 17 48-82	Spring Ext Elect Clutch
5	532 12 46-70	Retainer Spring	68	532 17 48-83	V-Belt
6	<b>532 17 80-24</b>	Bar Sway	91	<b>532 18 05-32</b>	Bracket Asm Noseroller Lh
8	532 85 08-57	Bolt, Hex 3/8-24 x 1.25 Gr. 8	92	873 80 06-00	Nut Lock Hex w/Ins. 3/8-16 Unc
9	810 03 06-00	Washer, Lock	94	532 13 22-64	Roller Nose 38"-50"
10	532 14 02-96	Washer, Hardened	95	<b>532 18 05-33</b>	Bracket Asm Noseroller Rh
11	532 13 84-98	Blade Mower 42" High Perf.	111	<b>532 17 92-92</b>	Bracket, Gauge, Wheel L.H.
	532 13 41-49	Blade, Mulching	112	<b>532 17 92-93</b>	Bracket, Gauge, Wheel R.H.
13	532 13 76-45	Shaft Assembly, Mandrel, Vented	113	<b>817 06 05-10</b>	Screw 5/16-18 x .625
14	532 12 87-74	Housing, Mandrel, Vented	114	873 51 05-00	Nut, Hex, Keps 5/16-18 UNC
15	532 11 04-85	Bearing, Ball, Mandrel	115	<b>872 11 05-05</b>	Bolt, Carriage 5/16-18 x 5/8
16	532 17 44-93	Stripper	116	532 12 48-72	Bolt, Shoulder
18	872 14 05-05	Bolt, Carriage 5/16-18 x 5/8	117	532 16 57-46	Wheel, Gauge
19	532 13 28-27	Bolt, Shoulder	118	873 93 06-00	Nut, Centerlock 3/8-16
20	532 15 97-70	Baffle, Vortex	119	819 12 14-14	Washer 3/8 x 7/8 x 14 Gauge
21	873 68 05-00	Nut Crownlock 5/16-18 UNC	129	819 13 13-12	Washer 13/32 x 13/16 x 12 Ga.
23	<b>532 17 75-63</b>	Bracket, Deflector	130	874 78 06-16	Bolt Hex 3/8-16 x 1.0
24	532 10 53-04	Cap, Sleeve	131	872 14 06-08	Bolt RDHD SQNK 3/8-16 x 1.0
25	532 12 37-13	Spring, Torsion, Deflector	132	817 06 06-12	Screw 3/8-16 x 3/4
26	532 11 04-52	Nut, Push	143	<b>532 15 71-09</b>	Bracket Arm Idler
27	532 17 18-59	Shield, Deflector	144	532 15 86-34	Keeper Belt 42" Clutch Cable
28	819 11 10-16	Washer 11/32 x 5/8 x 16 Ga.	145	532 16 58-88	Pulley Idler Flat
29	532 13 14-91	Rod, Hinge	146	532 17 19-77	Bolt Carriage Idler
30	<b>532 17 39-84</b>	Screw Thdrol	148	532 16 90-22	Spring Return Idler
31	532 12 99-63	Washer, Spacer	149	532 16 58-98	Retainer Spring Yellow Zinc
32	532 15 35-35	Pulley, Mandrel	150	819 09 12-16	Washer 9/32 x 3/4 x 16 Ga.
33	532 17 83-42	Nut, Toplock, Flanged	159	872 14 06-14	Bolt Rdhd Sqn 3/8-16 UNC x 1- 3/4
34	872 11 06-14	Bolt	182	<b>532 17 91-26</b>	Rod Roller Nose
36	532 13 14-94	Pulley, Idler, Flat	183	<b>532 16 35-52</b>	Retainer Spring
37	819 13 13-16	Washer 13/32 x 13/16 x 16 Gauge	--	532 13 07-94	Mandrel Assembly (Includes Housing, Shaft and Shaft Hardware Only-Pulley Not Included)
40	873 68 06-00	Nut Crownlock 3/8-16 UNC	--	532 17 62-07	Replacement Mower, Complete
44	532 14 00-88	Guard, Mandrel, L.H.			
45	532 12 47-88	Retainer			
46	532 13 77-29	Screw, Thd. Roll 1/4-20 x 5/8			
54	532 13 39-43	Washer, Hardened			

**NOTE:** All component dimensions given in U.S. inches  
1 inch = 25.4 mm